

Universal wall entry

without hem for installation in double walls/element walls

UDME100/400 KG

Article no.: 3030300230, GTIN: 4052487215947



- **with integrated flange connection**
- **No change in flow direction**

Optimized flow through wall penetration - prevents deposits and back water in the sewer system. Three 3-ribbed seals for sealing in double walls/element walls.

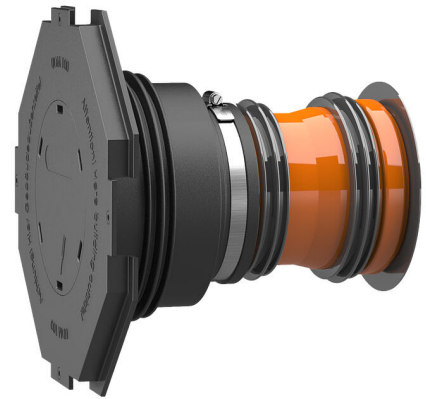

Picture may differ from selected product

FACTS

Advantages:

- Available adapted to wall thickness ready for installation
- Three 3-ribbed seals for use in double walls/element walls
- Pressure-tight after concreting

Scope of delivery:

- 1 piece Rubber sleeve with integrated 3-ribbed seal
- 1 piece Clamping strap
- 1 piece Sleeve cover with flange connection and blind cover for tapping in
- 2 additional 3-ribbed seals
- 1 piece Lamella plugs
- 1 piece KG (2000) pipe (pre-mounted ready for installation)



Dimensions:

- DN 110: minimum wall thickness 240 mm
- DN 150: minimum wall thickness 300 mm

Properties:

- For installation flush with the formwork
- Blind sealed ready for installation
- Available in KG and KG 2000 quality

Application range:

- DIN 18533 W1-E, DIN 18533 W2.1-E
- Waterproof concrete stress class 1, waterproof concrete stress class 2

Material:

- Rubber sleeve and 3-ribbed seals: EPDM
- Sleeve cover: ABS
- Clamping strap: Steel St sn (W1)
- Lamella plugs: PE
- KG pipe: PVC-U/KG 2000 pipe: PP

Tightness:

- gastight and watertight
- radon tight

Tests/Standards:

- KG 2000 pipes to DIN EN 14758
- KG pipes to DIN EN 13476-2

FEATURES

Nominal diameter of KG pipe:	DN 100
Suitable for medium pipe OD (mm):	110 mm
wall thickness (mm):	400
Packing unit:	1

PICTURES

