

# Connection wall sleeve

## AFR 100/250

Article no.: 3030300006, GTIN: 4052487143035



### • Integrated flange connection

For the direct connection of a smooth duct DN 110 with plug-in/glue-in socket.

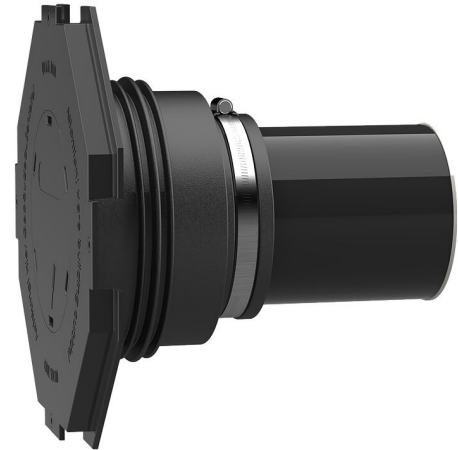

Picture may differ from selected product

## FACTS

### Advantages:

- For the direct connection of a plug-in/glue-in socket DN 110
- Available adapted to wall thickness ready for installation
- Pressure-tight after concreting

### Scope of delivery:

- 1 piece Rubber sleeve with integrated 3-ribbed seal
- 1 piece Clamping strap
- 1 piece Sleeve cover with flange connection and blind cover for tapping in
- 1 piece Wall sleeve
- 1 piece Plastic pipe DN 110 (everything pre-mounted ready for installation)



## Properties:

- For installation flush with the formwork
- Blind sealed ready for installation

## Application range:

- DIN 18533 W1-E, DIN 18533 W2.1-E
- Waterproof concrete stress class 1, waterproof concrete stress class 2

## Material:

- Rubber sleeve: EPDM
- Sleeve cover: ABS
- Clamping strap: Steel St sn (W1)
- Closing cover: PE
- Pipe: PVC-U

## Tightness:

- gastight and watertight
- radon tight

## FEATURES

D1 (mm):	100
D2 (mm):	110
D4 (mm):	260
D3 (mm):	290
wall thickness (mm):	250
Packing unit:	1

## PICTURES

